

PAD HOLDER DIMENSIONS					
PAD MODEL	H	W	A	B	DEPTH
1426	28	3	28 13/16	2 1/2	15
1818	20	3 1/4	20 13/16	2 1/2	19
2424	26	3 3/4	26 13/16	2 1/2	25
1426-LS	28	4	28 13/16	3 1/2	15
1818-LS	20	4	20 13/16	3 1/2	19
2424-LS	26	4 1/2	26 13/16	3 1/2	25

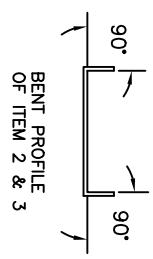
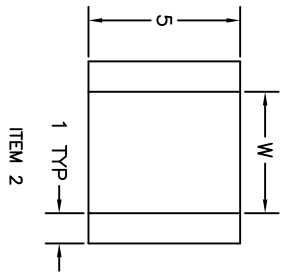
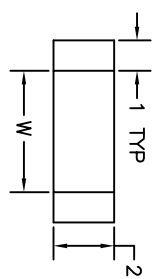
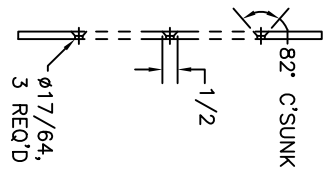
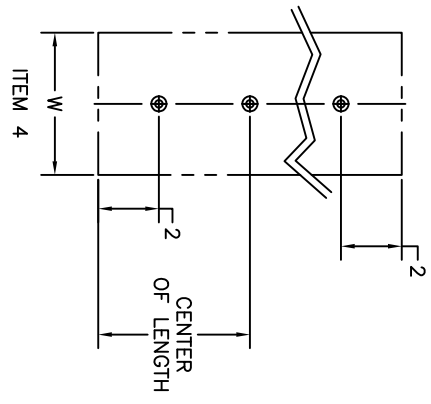
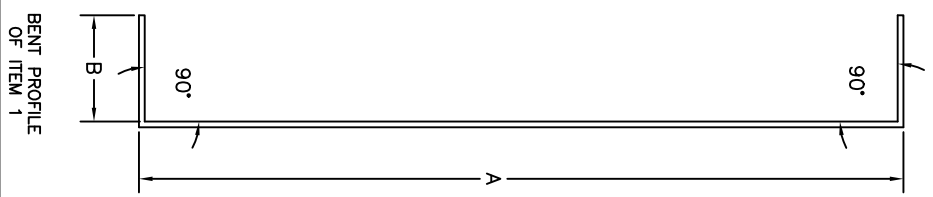
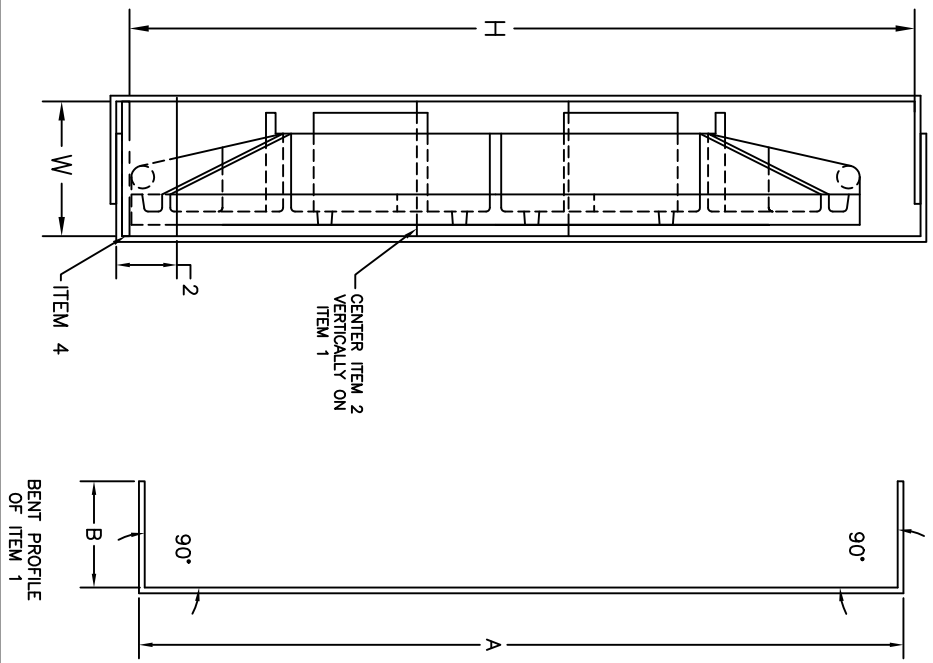

NOTE:
SHEAR ITEM 1 SO THERE
IS A CONTINUOUS METAL EDGE
FOR THE FRONT & REAR EDGES.

Information on this print
is of proprietary nature
and is not to be copied.
This design is the property
of Sauber Mfg. Co.

SAUBER MFG. CO.
10 N. SAUBER ROAD
VIRGIL, IL 60151-1000
(630) 365-6600

SAUBER MFG. CO. VIRGIL, IL

DRN	EJB	TITLE	SAUBER MFG. CO. VIRGIL, IL
OK'D			
AP'VD			
		IDENT NO.	DATE
		5353ST	09/05/2003
		SCALE 3" = 1'	SHEET 1 OF 1